

Bunja “AMA1” na lokalitetu Stàre Fruščèli
u zaleđu mjesta Punat na otoku Krku

graditelj: Antòn Mràkovčić Àndre (1843. – 1940.)

snimili: Olenka Puškaš i Berislav Horvatić
26. srpnja 1998.

nacrtala: Olenka Puškaš, apsolventica arhitekture

1. situacija
2. WNW pogled
3. NNE pogled
4. SSW pogled
5. ESE pogled
6. pogled odozgo
7. horizontalni presjek A – A (iznad ulaza)
8. horizontalni presjek B – B (kroz ulaz)
9. vertikalni presjek C – C (ESE – WNW)
10. vertikalni presjek D – D (NNE – SSW)

"AMA 1" - situacija

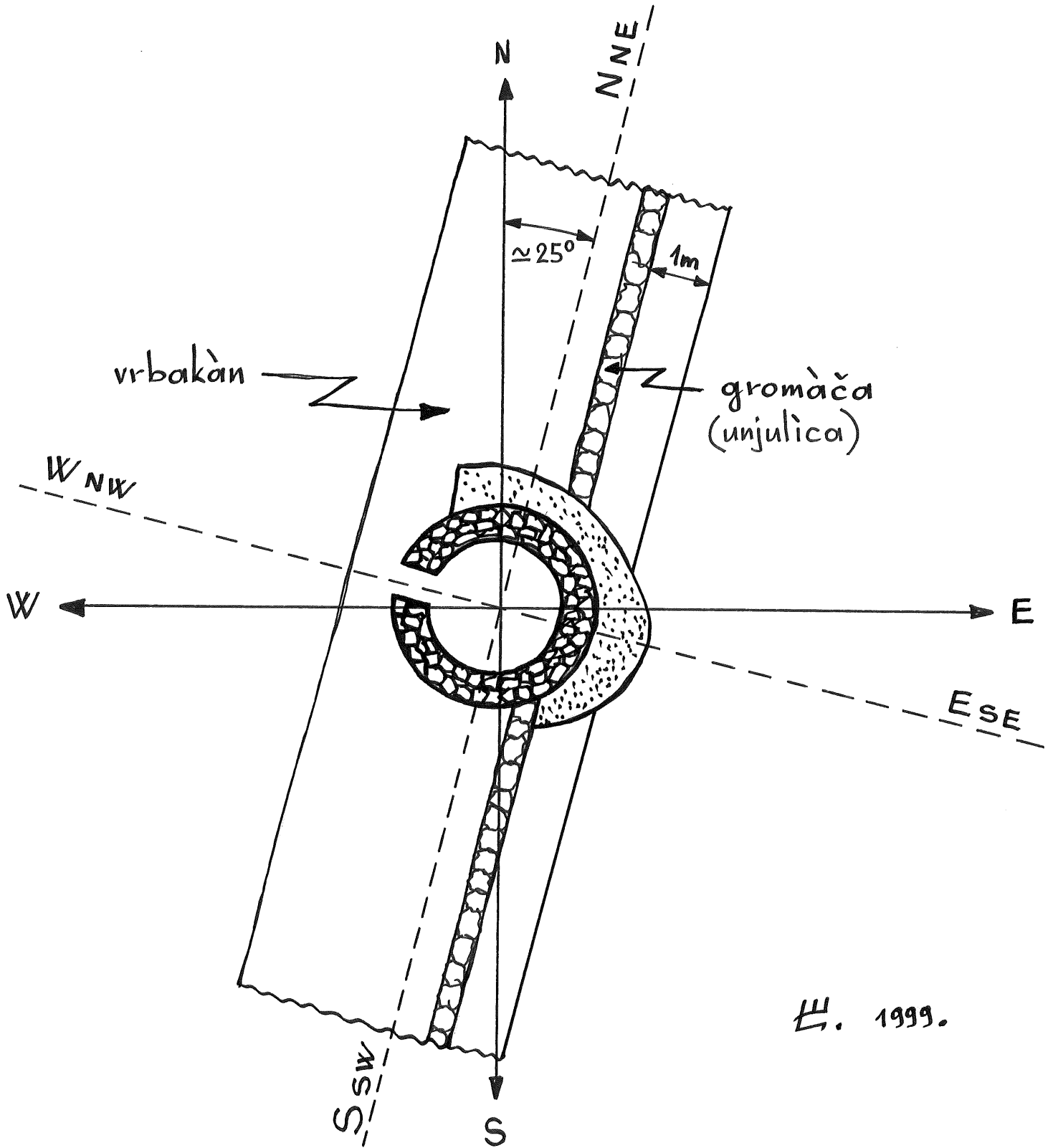

WNW pogled

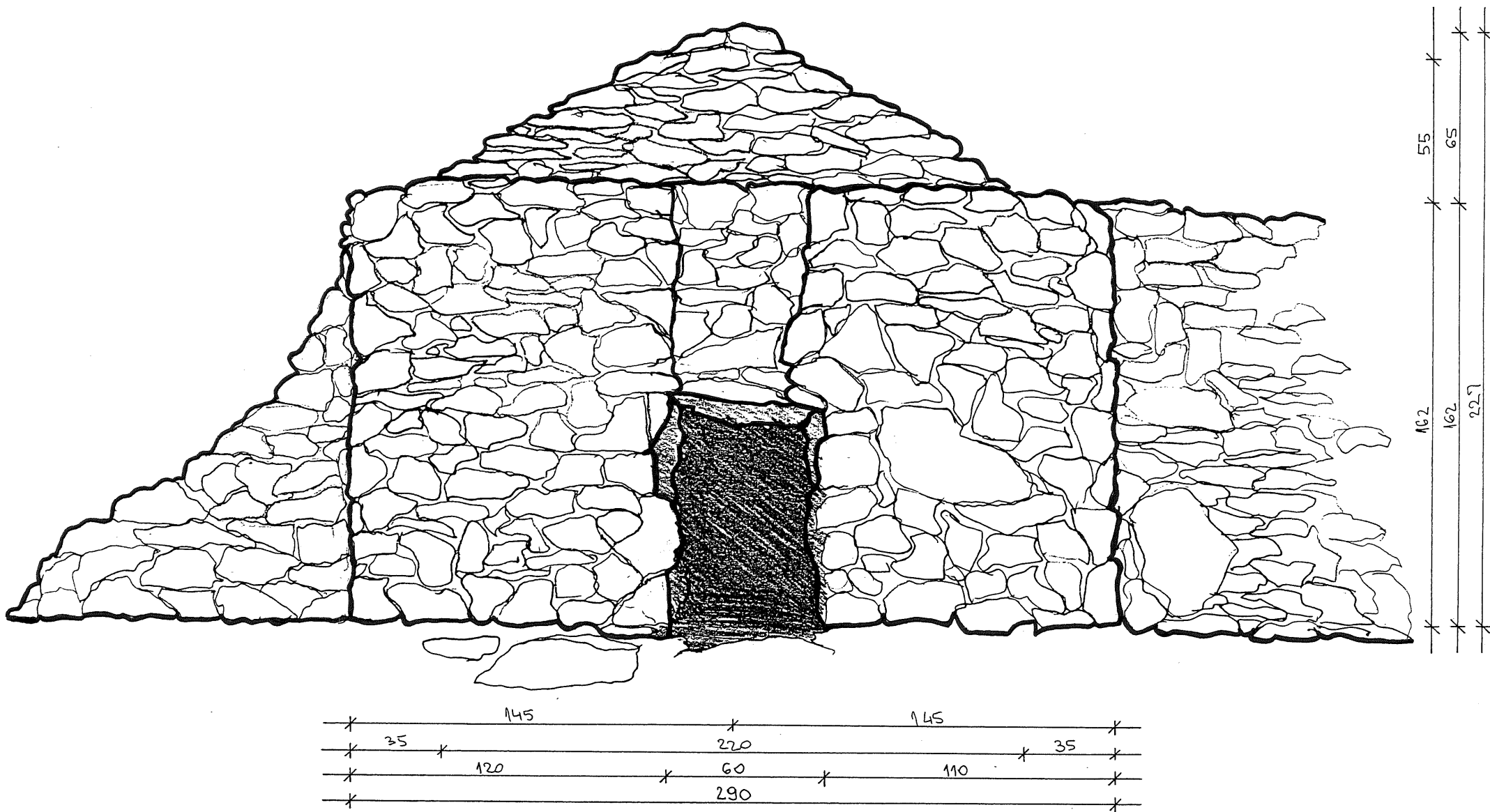

OLENKA PUŠKAČ, 1998.

NNE pogled

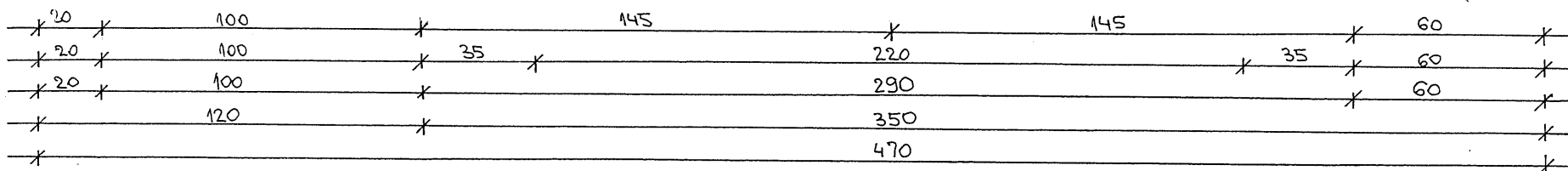
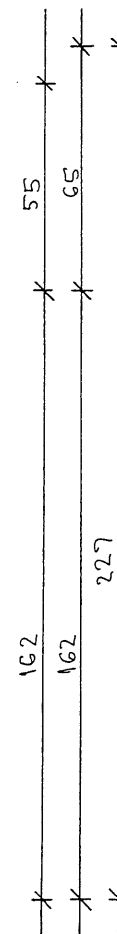
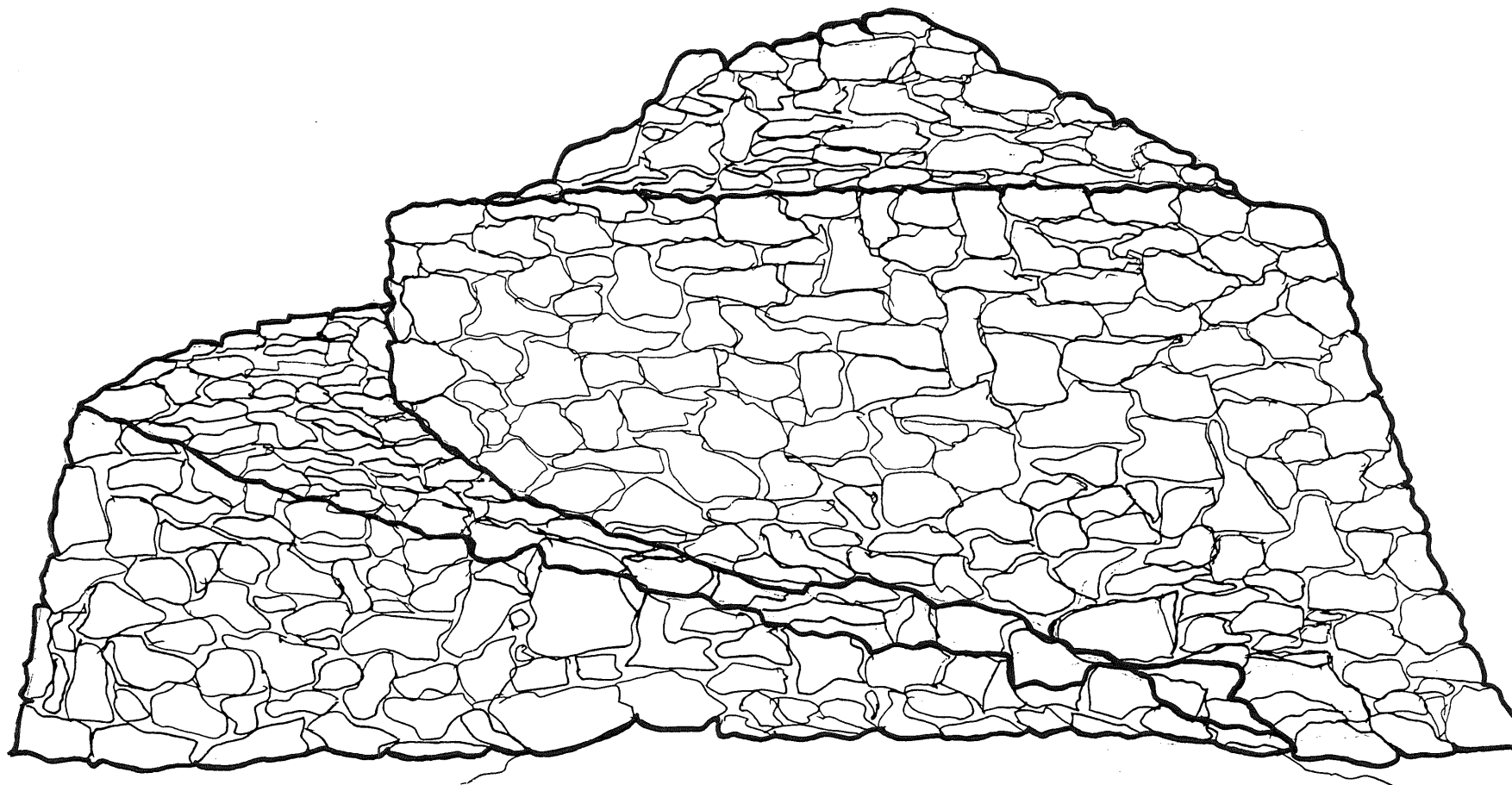

OLENKA PUŠKAŠ, 1998.

SSW pogled

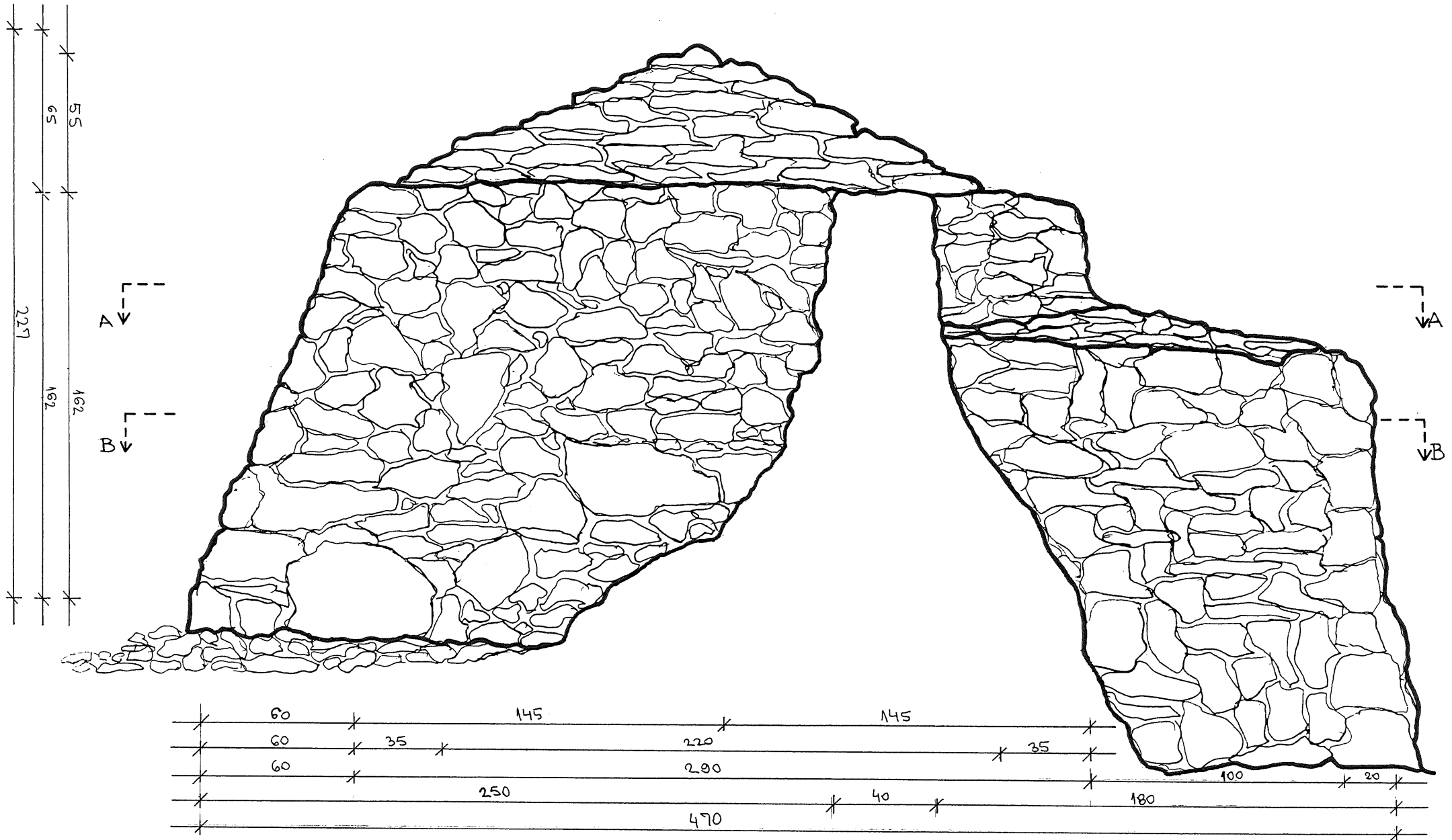

OLENKA PUŠKAŠ, 1998.

ESE pogled

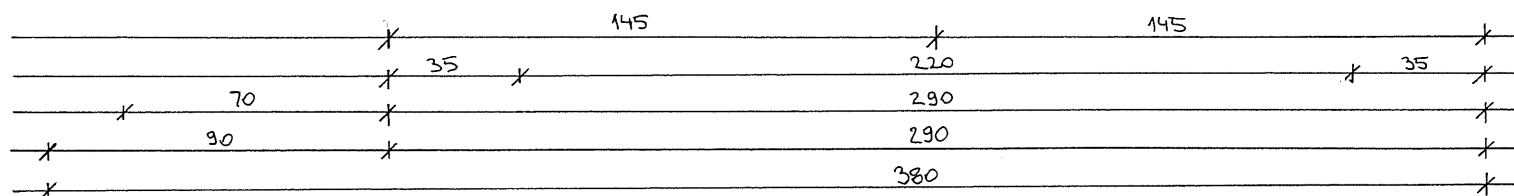
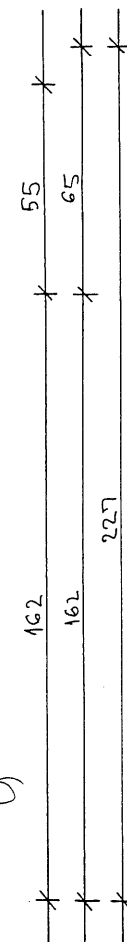
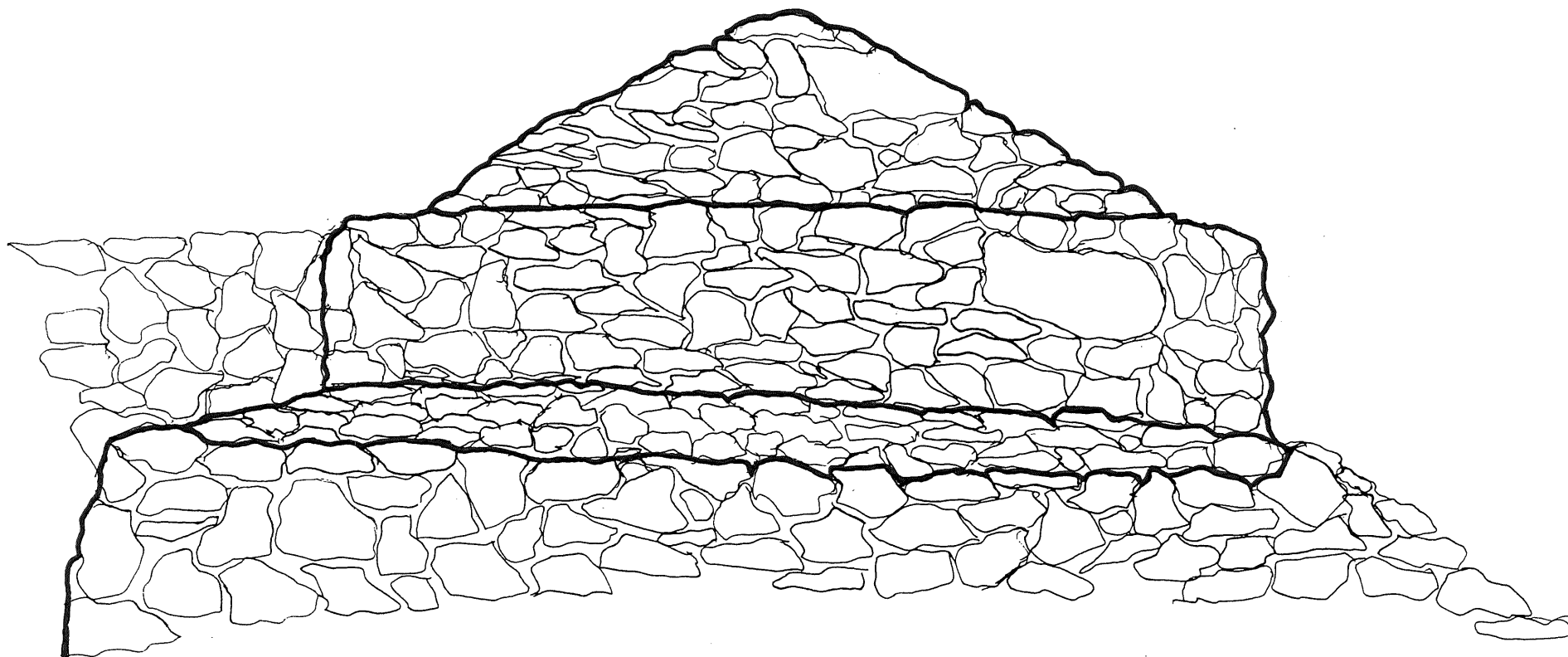

OLENKA PUŠKAŠ, 1998.

pogled odozgo

↗
c

↑
D

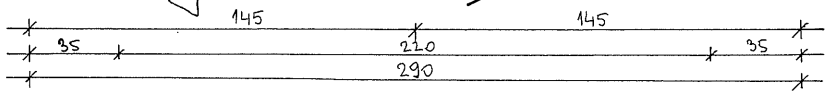
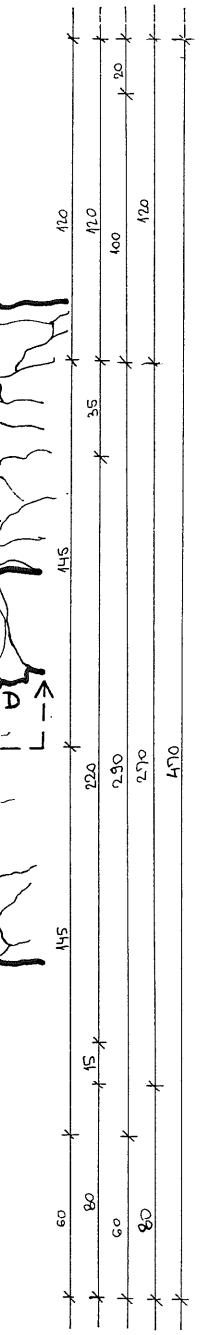

↘
c

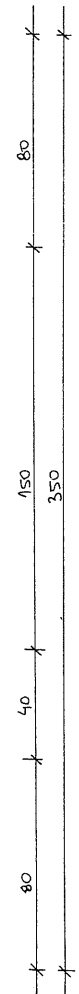
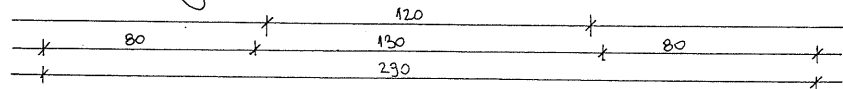
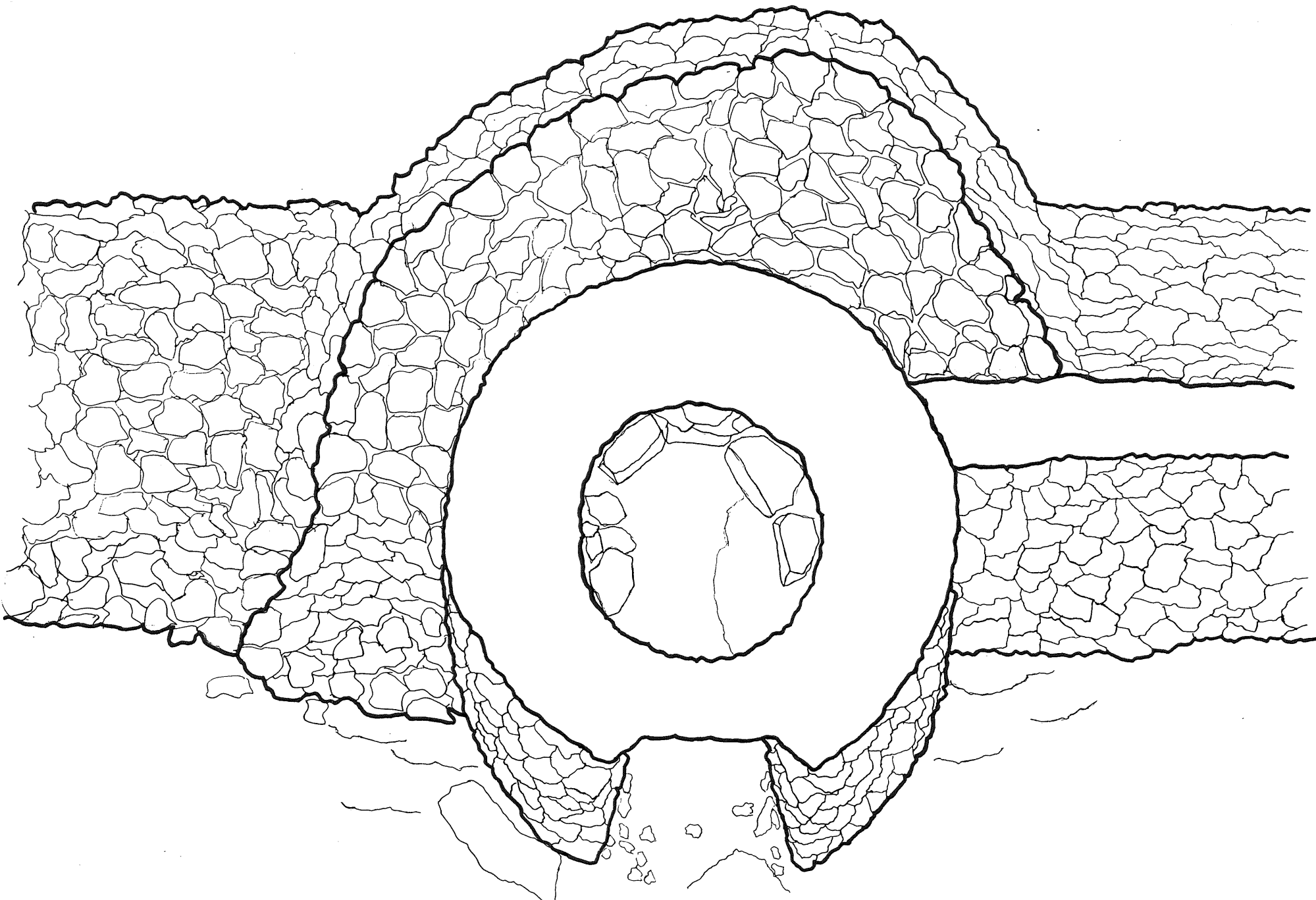

horizontalni presjek kroz osnovicu

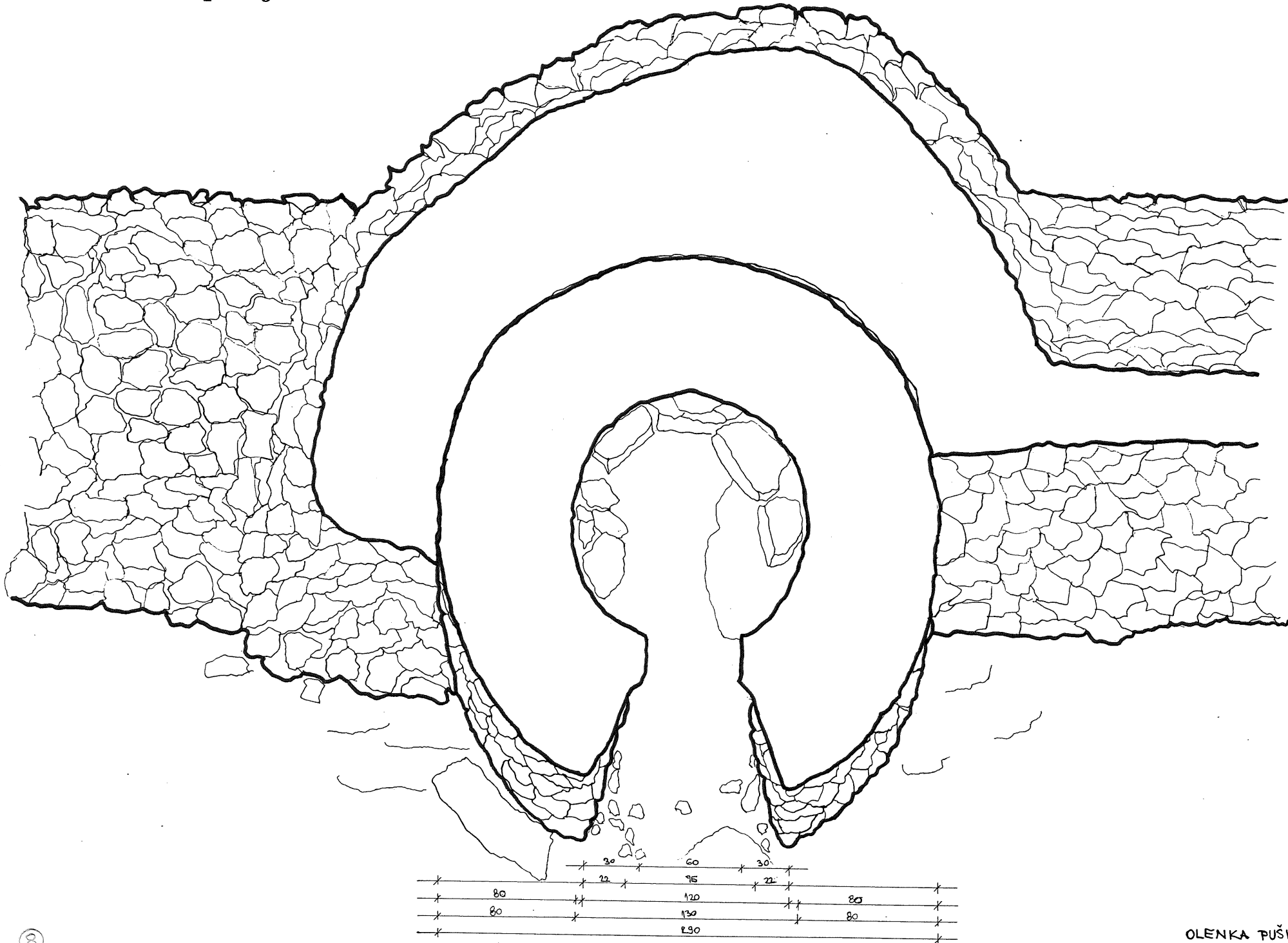

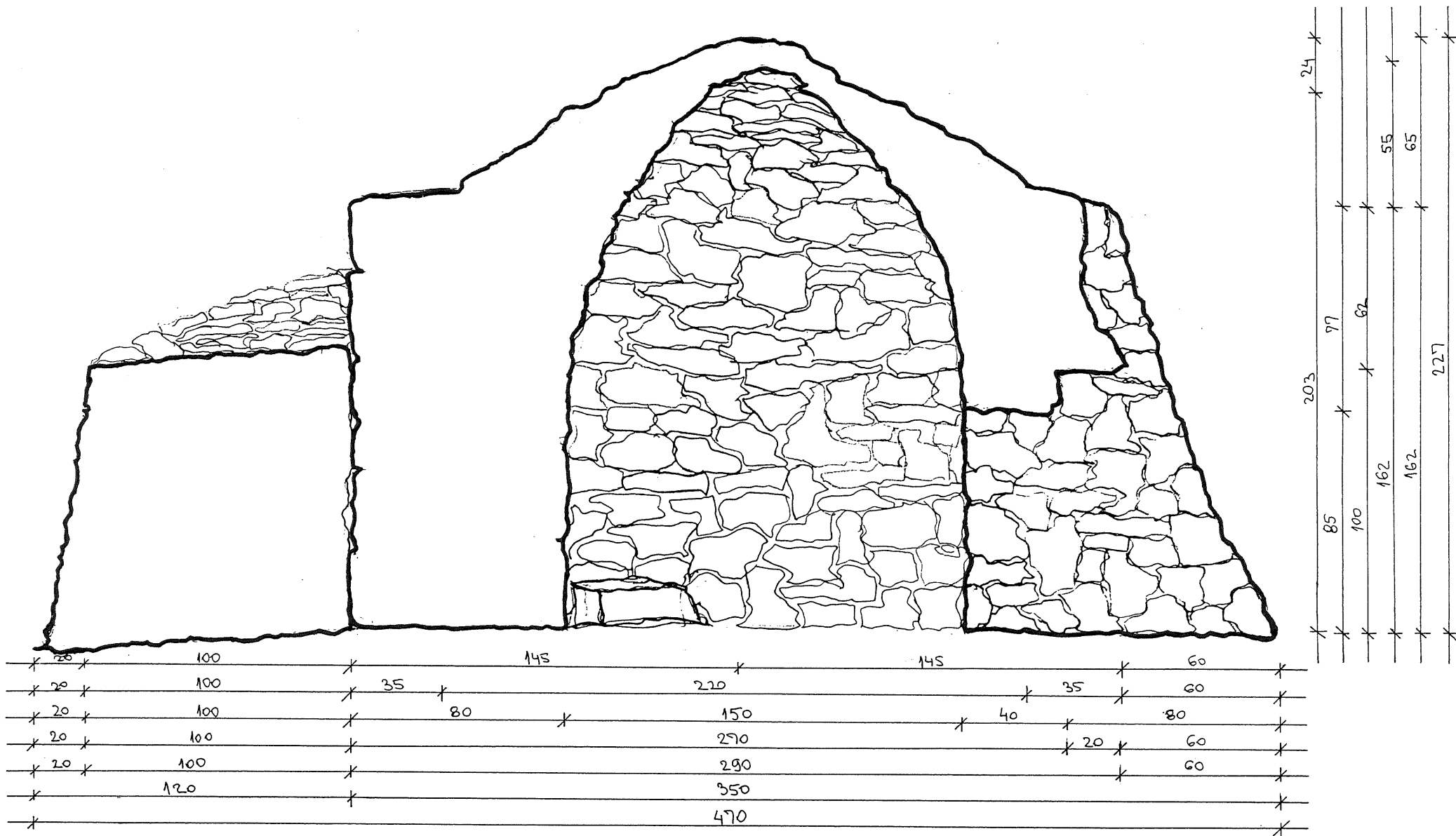

OLENKA PUŠKAŠ, 1998.

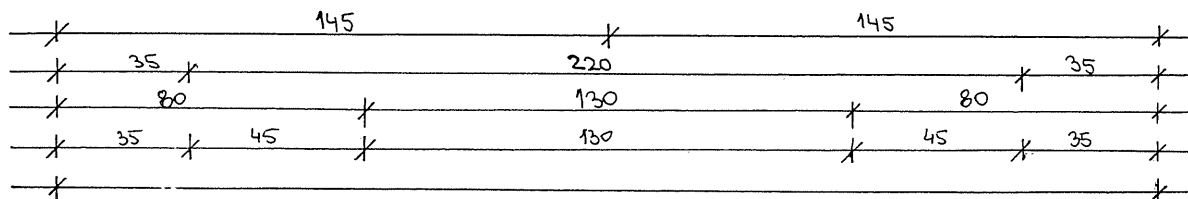
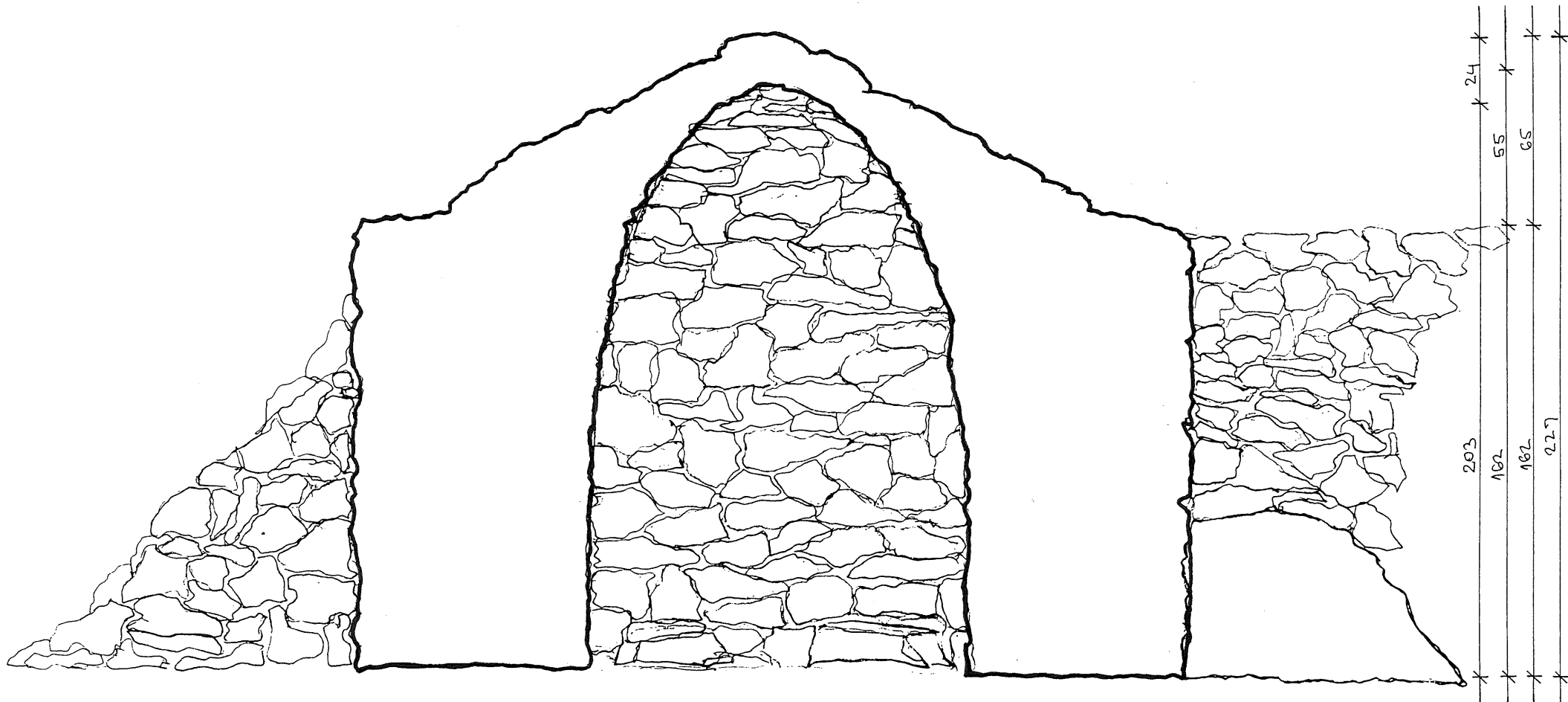

OLENKA PUŠKAŠ, 1998.